



Neuschwanstein

CASTLE



Step by step instructions

1. Print all pages, recommended paper 50 lb.
2. Cut out **Base** on page 1. This part is flat.
3. Cut out **Upper Courtyard**, fold it and glue to **Base**

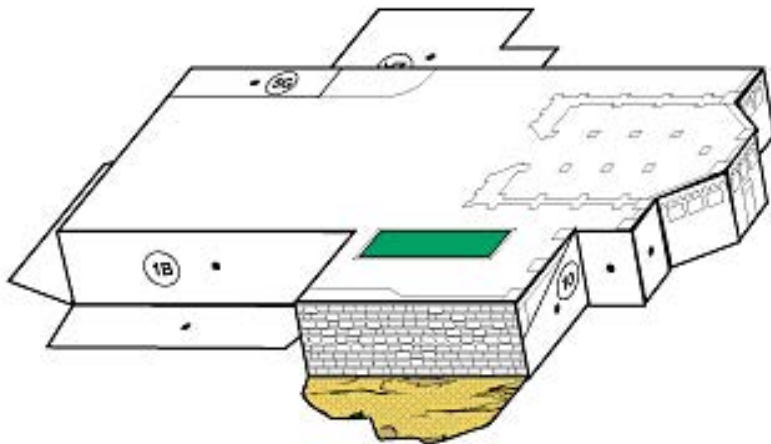

Note

what does mean here
"fold inside" and "fold outside"

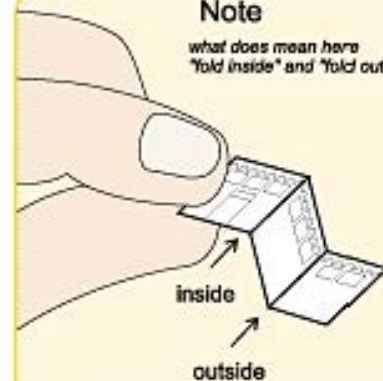

4. Fold and glue **Kemenate Building**

(better, at first glue walls, then glue building to the **Base** and **Upper Courtyard**, and in last turn glue roof)



Note

if some parts are too
narrow for fingers,
use a pencil (or a ruler)
to press

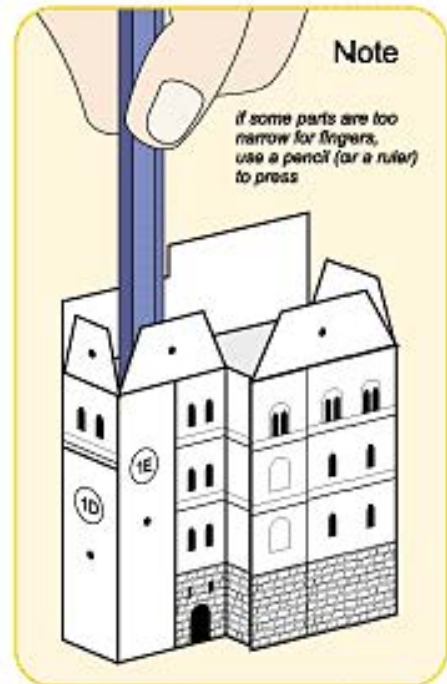

5. Fold and glue small tower on **Kemenate Building** roof

see 1F



6. Fold **Knights' House** and glue to the **Base**

(also this building is glued
to **Upper Courtyard**)

7. Fold **Big Building 1** and glue to the **Base**

(also this building is glued to Upper Courtyard and Kamenate Building)

(better, at first glue walls, then glue building to the Base using a pencil to press, and in last turn glue roof)



8. Fold **Wall 1** and **Wall 2**, and glue to the **Base**

(also Wall 1 is glued to Upper Courtyard, Big Building 1 and Knights' House. Wall 2 is glued to Upper Courtyard and Knights' House)

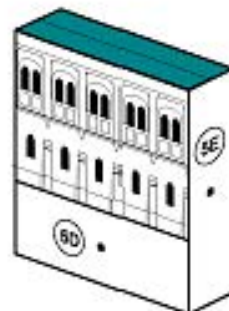
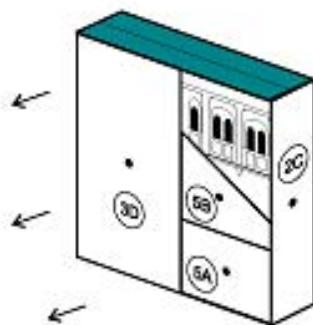

9. Fold **Tower 1** and **Tower 2**, and glue to the **Base**

(also Tower 1 is glued to Kamenate Building. Tower 2 is glued to Kamenate Building and Big Building 1)

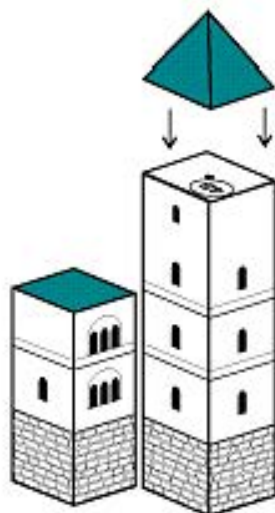

10. Fold and glue **Staircase 1**

(Staircase 1 is glued to Upper Courtyard, Wall 1, Knights' House and Big Building 1)

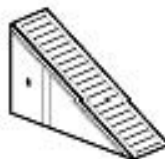

11. Fold and glue **Tower 3**

(Tower 3 is glued only to Knights' House)

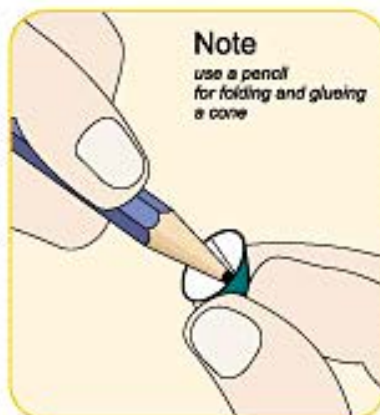

Note

use a pencil for folding and gluing a cone

12. Fold Tower 4 and glue to the Base
(also Tower 4 is glued to Big Building 1 and Wall 1)



13. Fold Big Square Tower and glue to the Base
(also Big Square Tower is glued to Upper Courtyard and Wall 2)

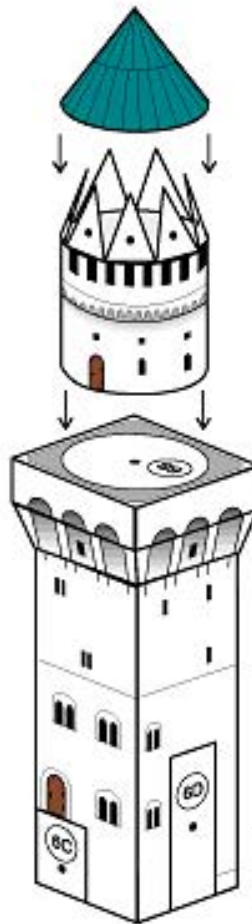

14. Fold Wall 3 and glue to the Base

(also Wall 3 is glued to Big Square Tower)



15. Fold Gate House and glue to the Base

(also Gate House is glued to Wall 3)

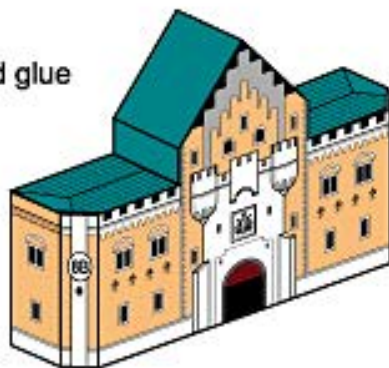

16. Fold Left and Right Towers of Gate House and glue those to Gate House



Left Tower of Gate House



Right Tower of Gate House

17. Fold Staircase 2 and glue to the Base

(also Staircase 2 is glued to Wall 3 and Gate House)



18. Fold **Big Building 2** and glue to the **Base**

(also *Big Building 2* is glued to *Big Building 1*)

(better, at first glue walls, then glue building to the **Base** using a pencil to press, and in last turn glue roof)

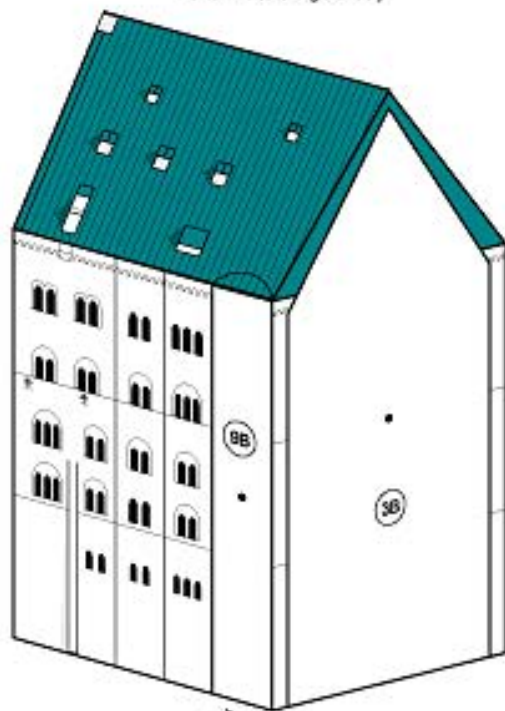

19. Fold **Round Tower 1** and glue to the **Base**

(also *Round Tower 1* is glued to *Big Building 2*)



(note, this is a section of top part of the Tower)



(note, this is a section of bottom part of the Tower)



20. Fold **Round Tower 2** and glue to the **Base**

(also *Round Tower 2* is glued to *Big Building 2*)

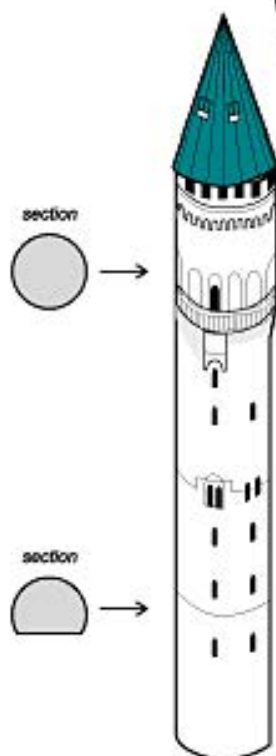

21. Fold **Staircase 3** and glue to the **Base**

(also *Staircase 3* is glued to *Upper Courtyard*)

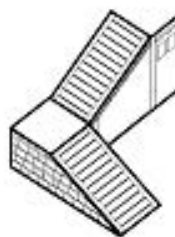

View of Staircase 3 from another side



Now your Neuschwanstein Castle is ready. Have fun!

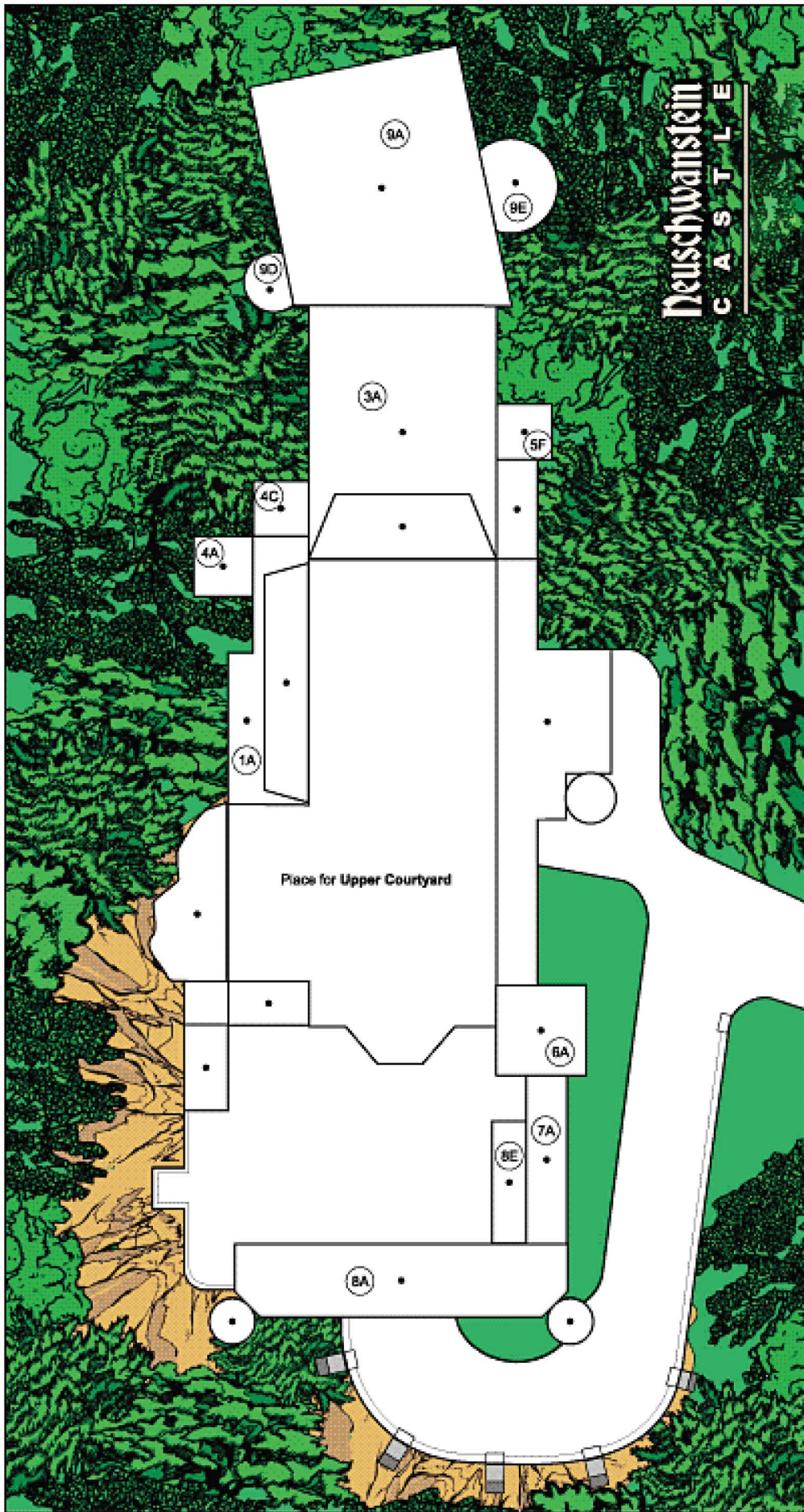

Base

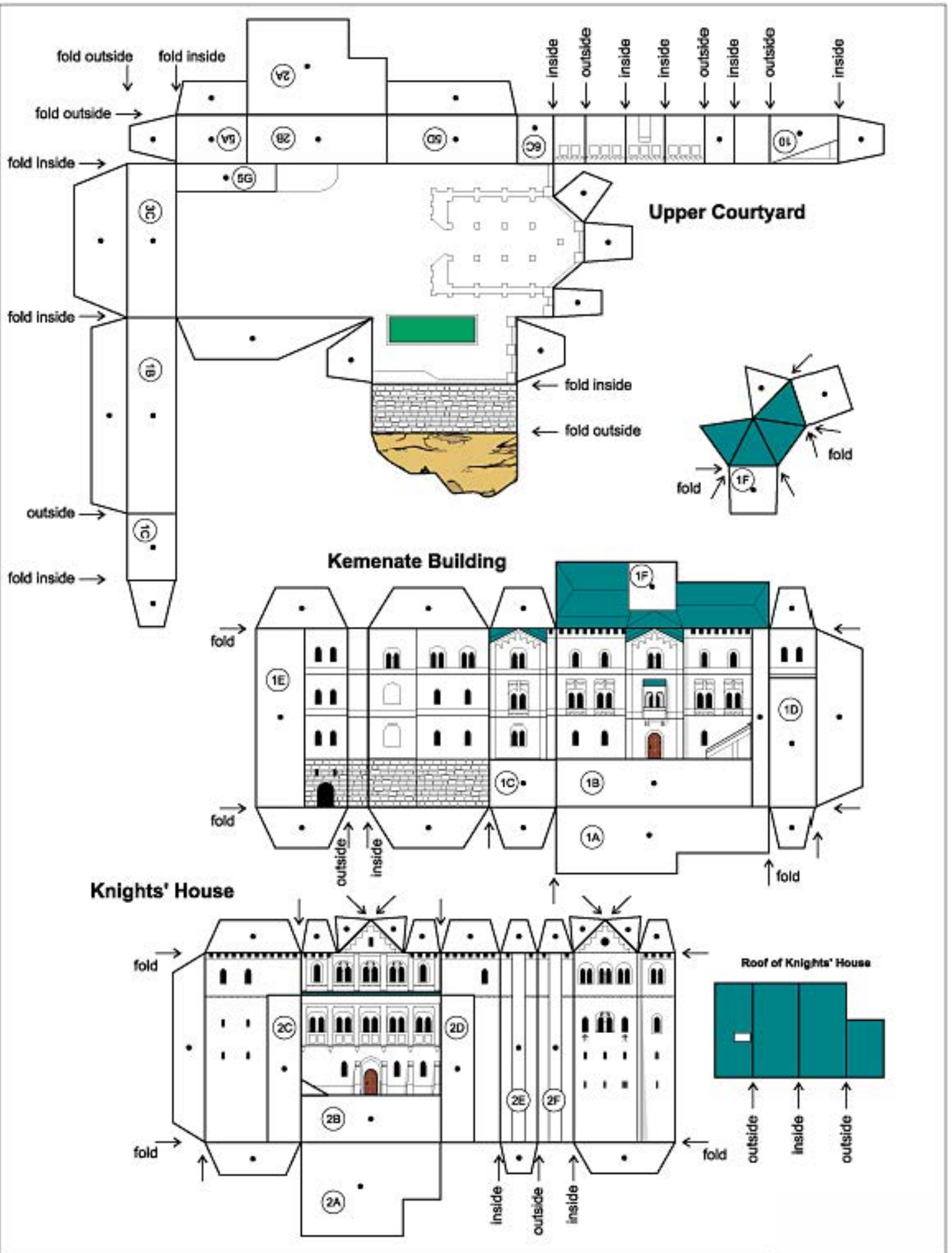

Big Building 1

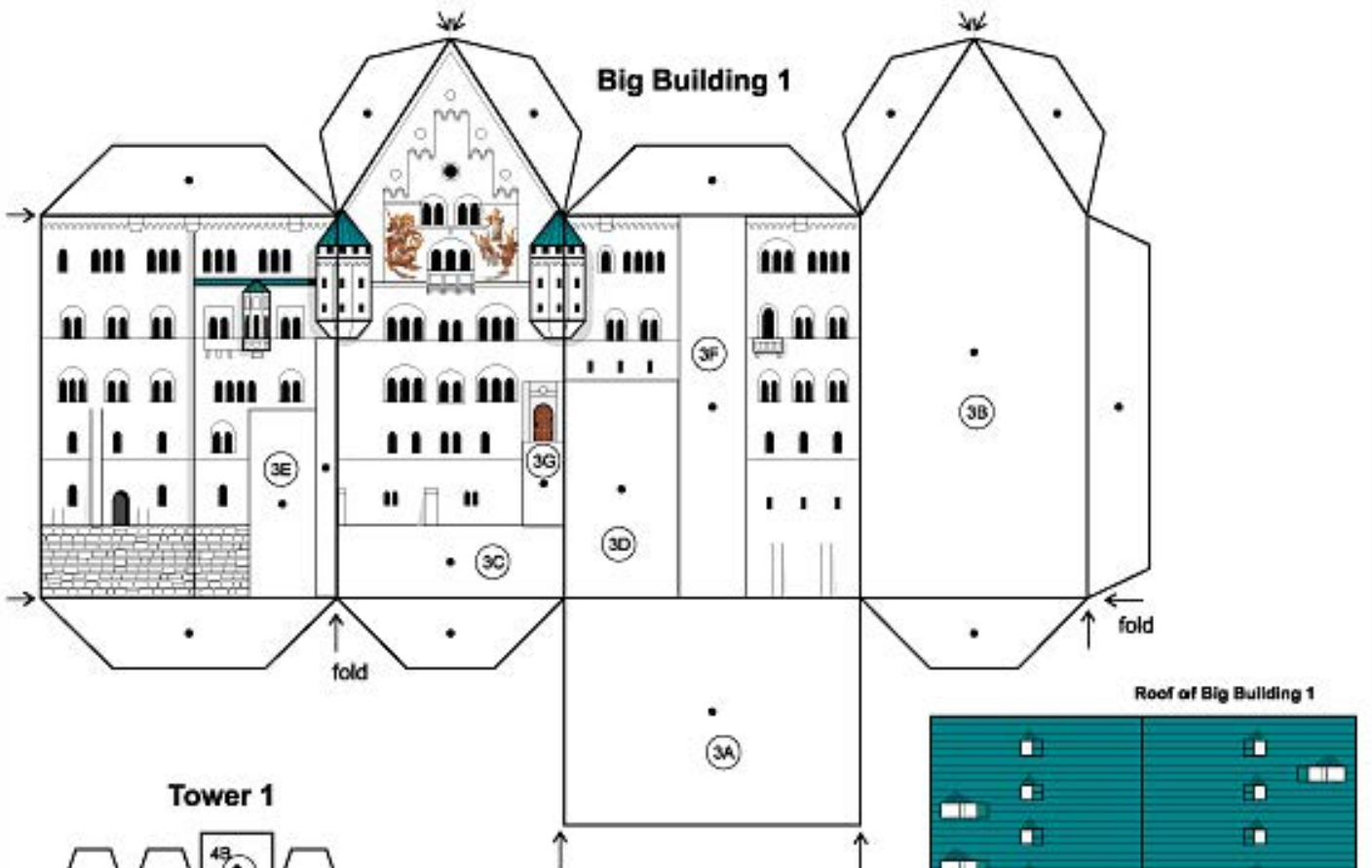

Roof of Big Building 1

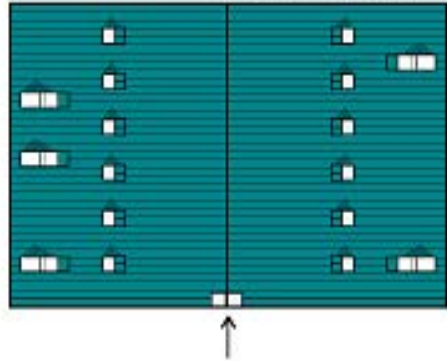

Tower 1

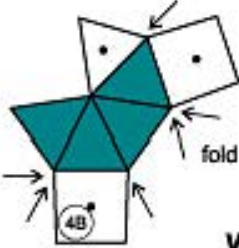
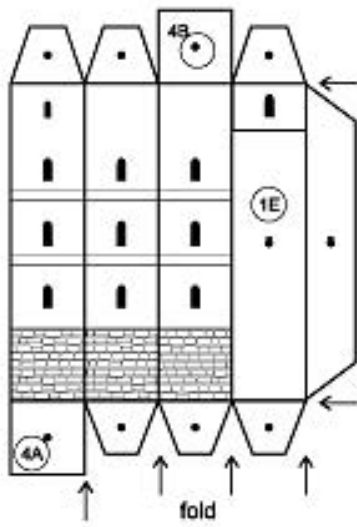

Wall 1

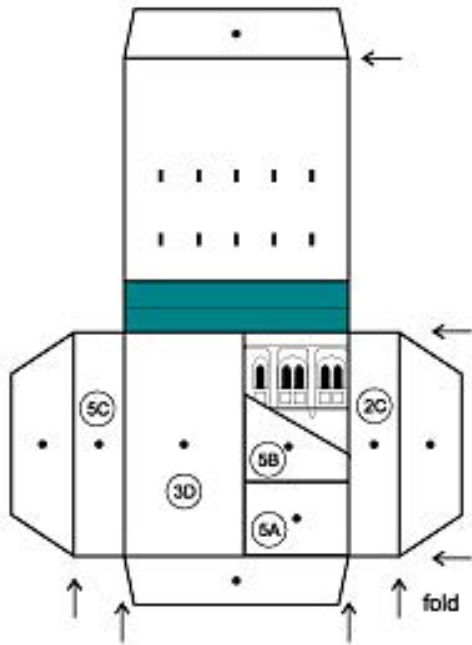

Wall 2

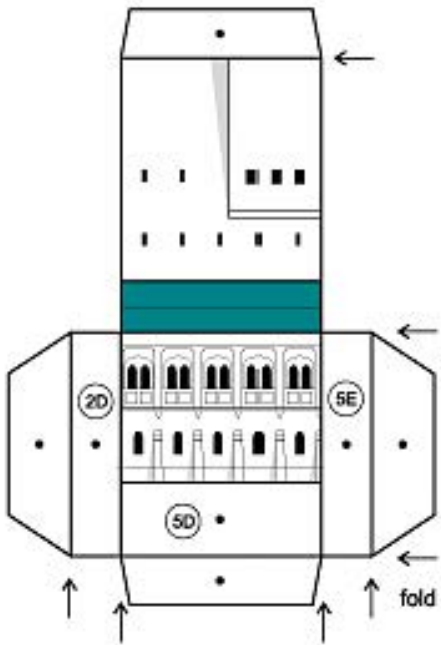

Tower 2

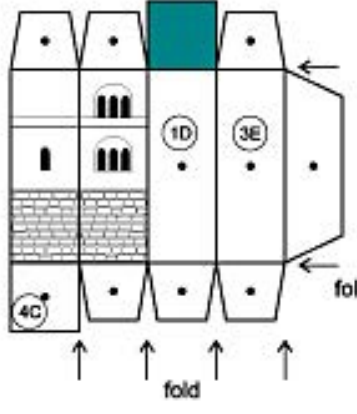

Staircase 1

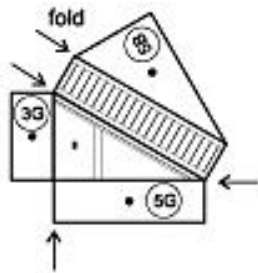

Tower 3

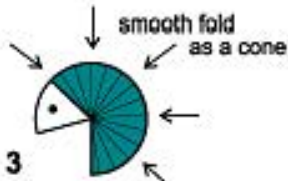
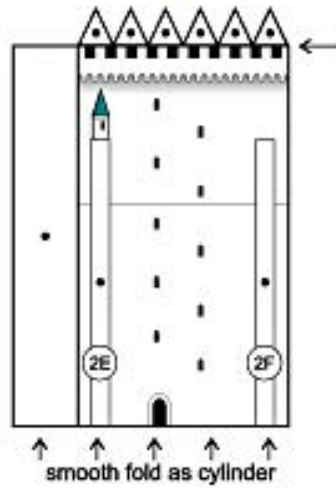

Tower 4

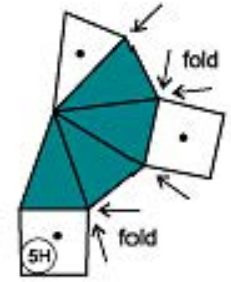
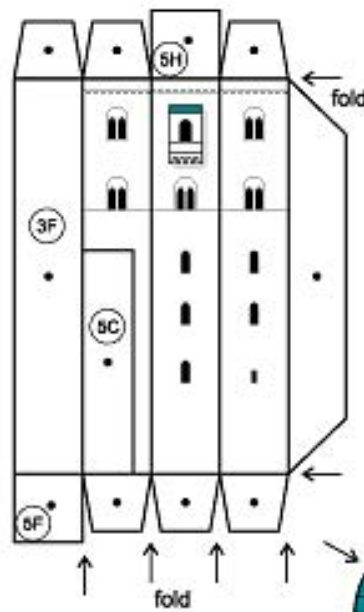

Big Square Tower

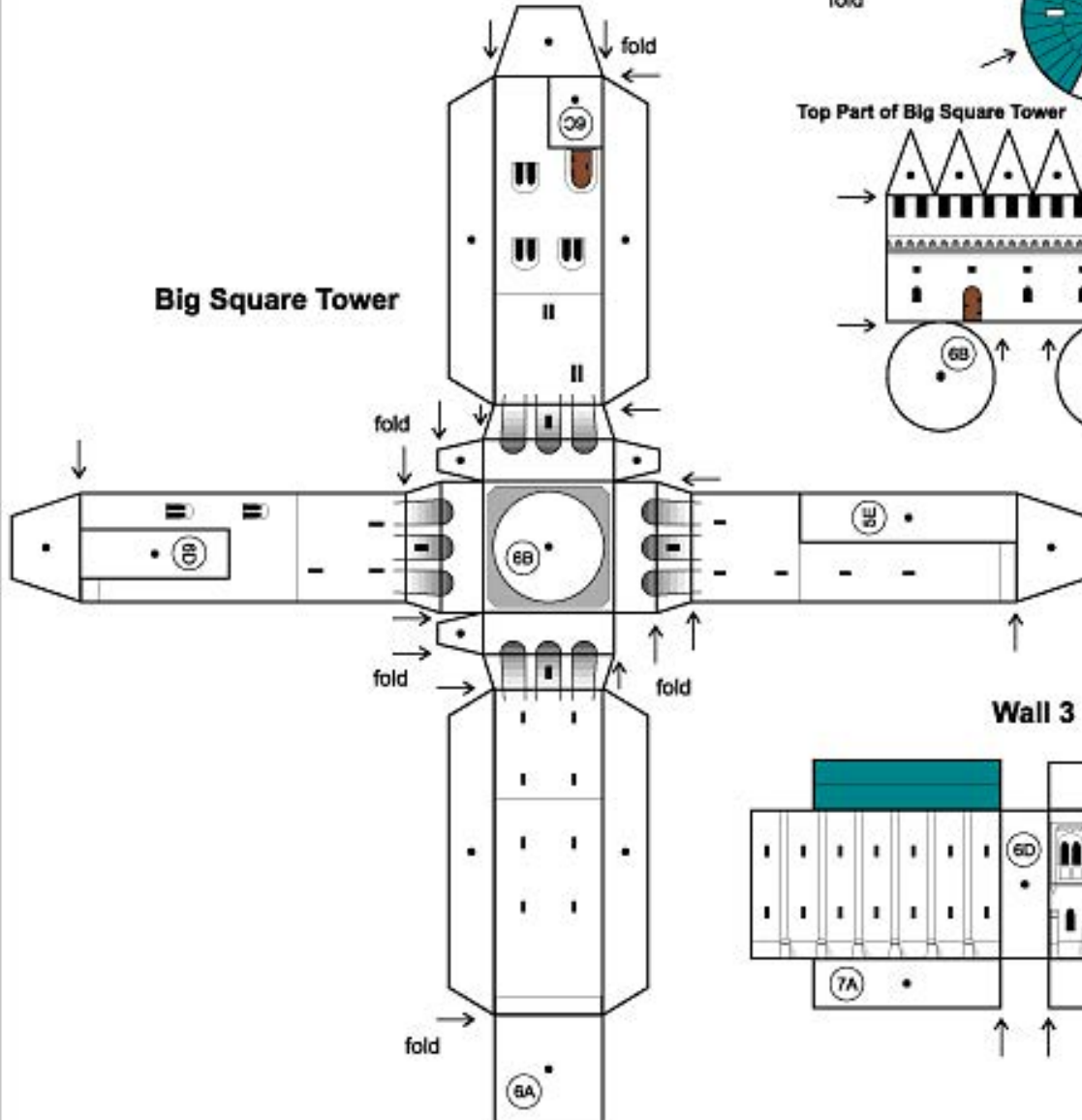

Top Part of Big Square Tower

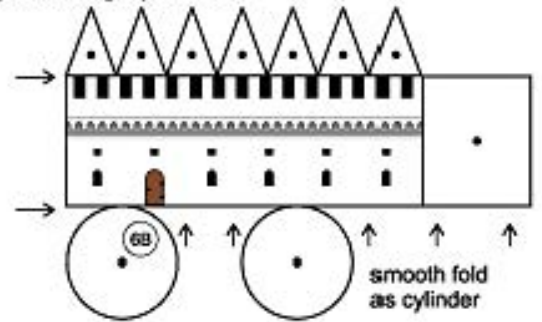

Wall 3

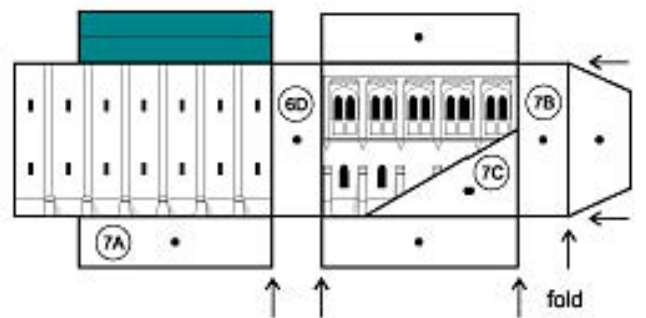

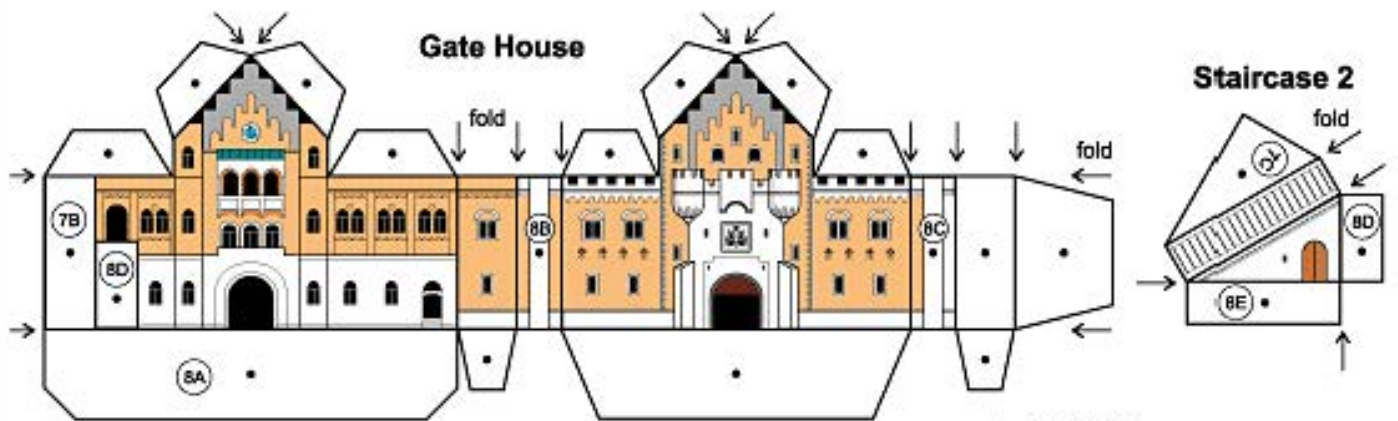

Left Tower of Gate House Right Tower of Gate House

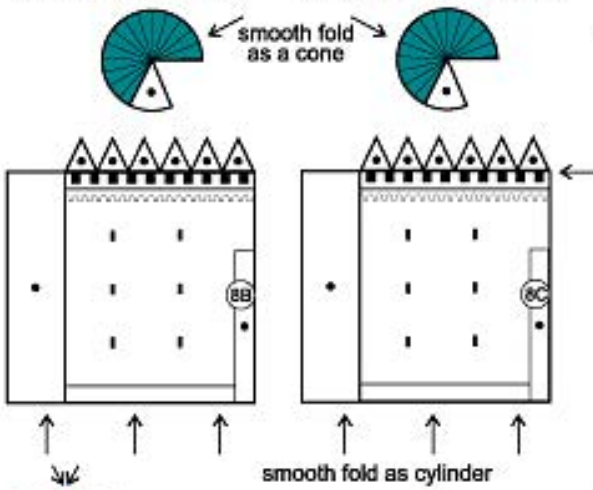

Roof of Gate House

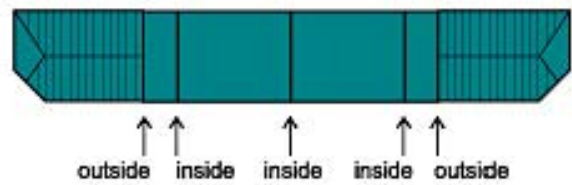

Roof of Big Building 2

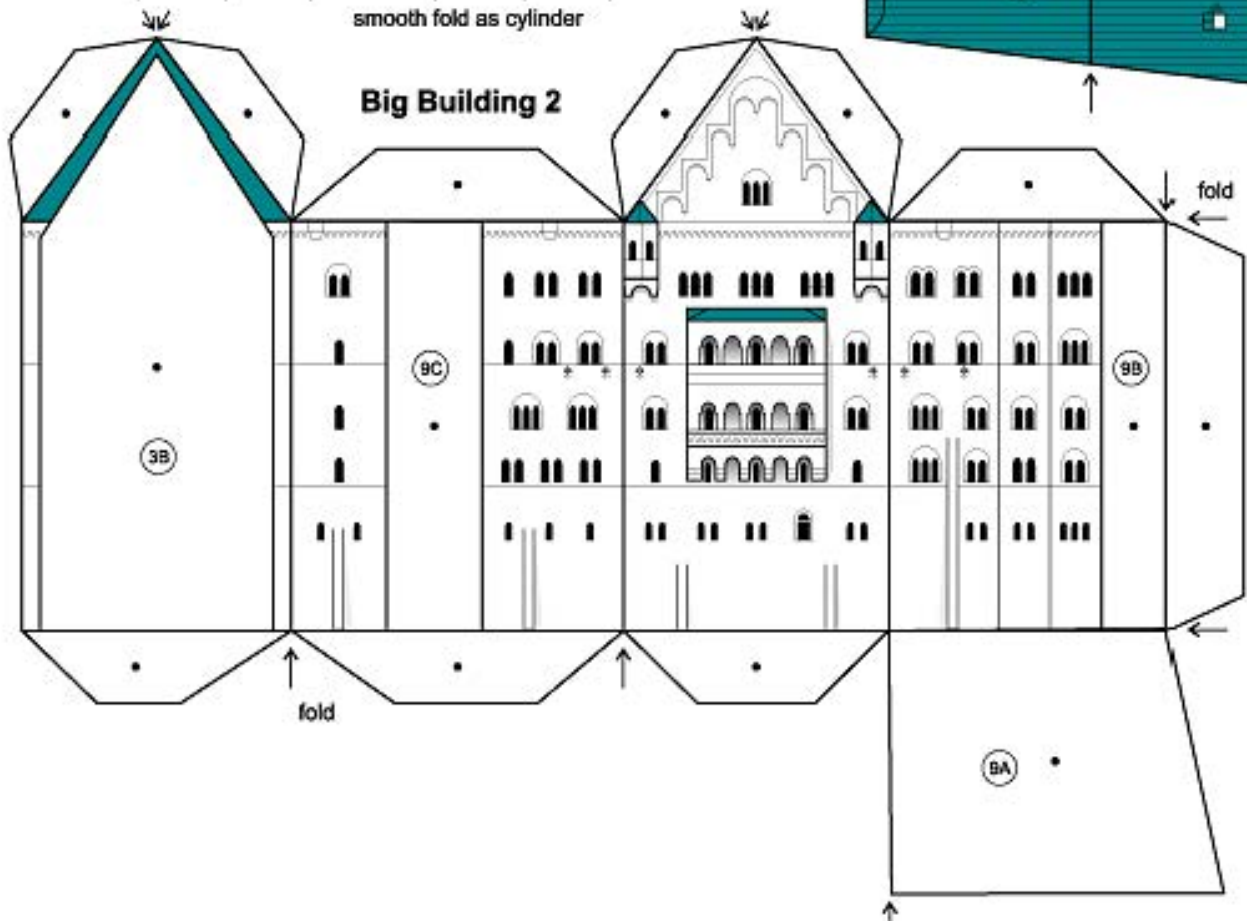
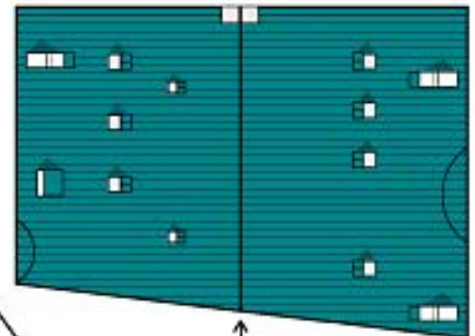

Round Tower 1

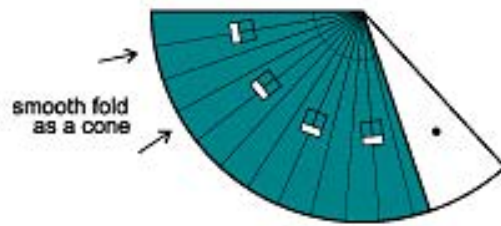

Round Tower 2

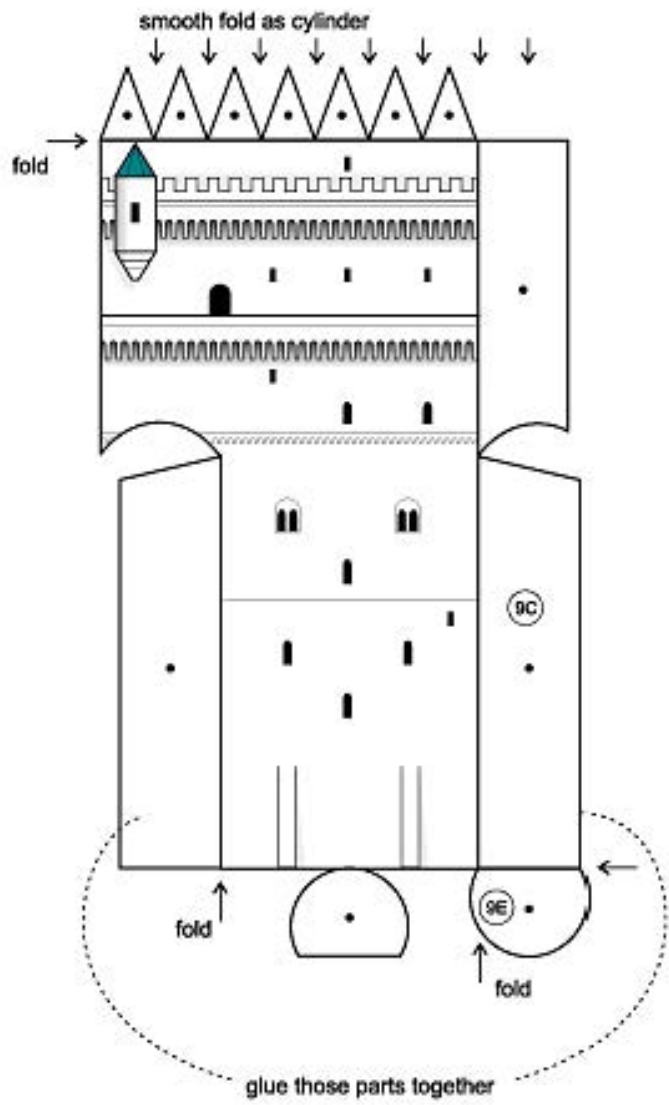
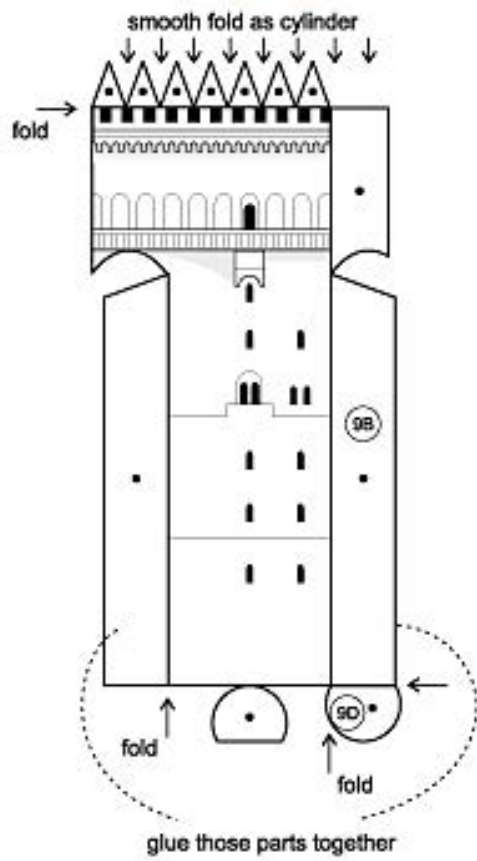
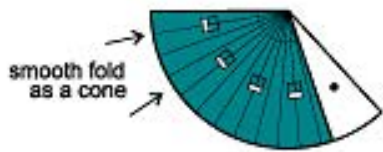

Staircase 3

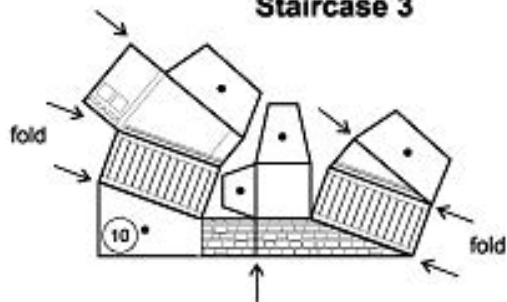

Neuschwanstein

CASTLE



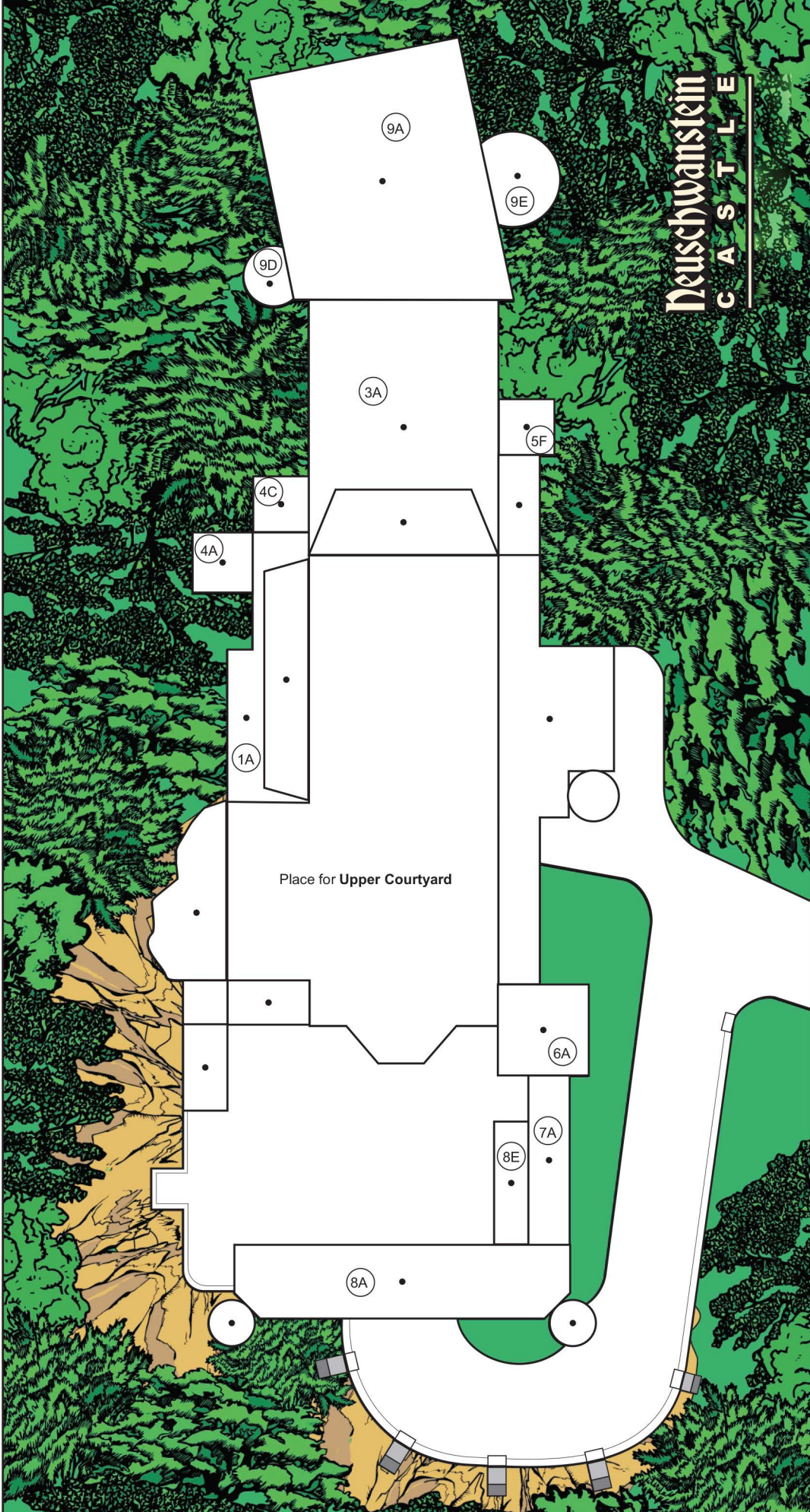

Neuschwanstein
CASTLE

Base

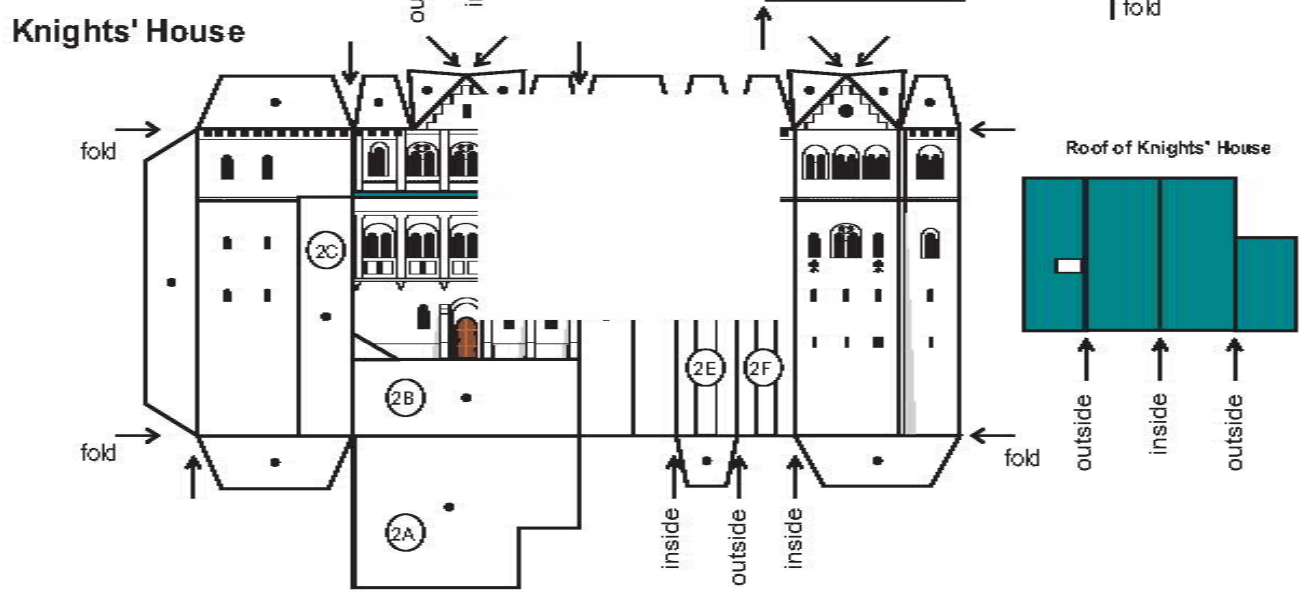
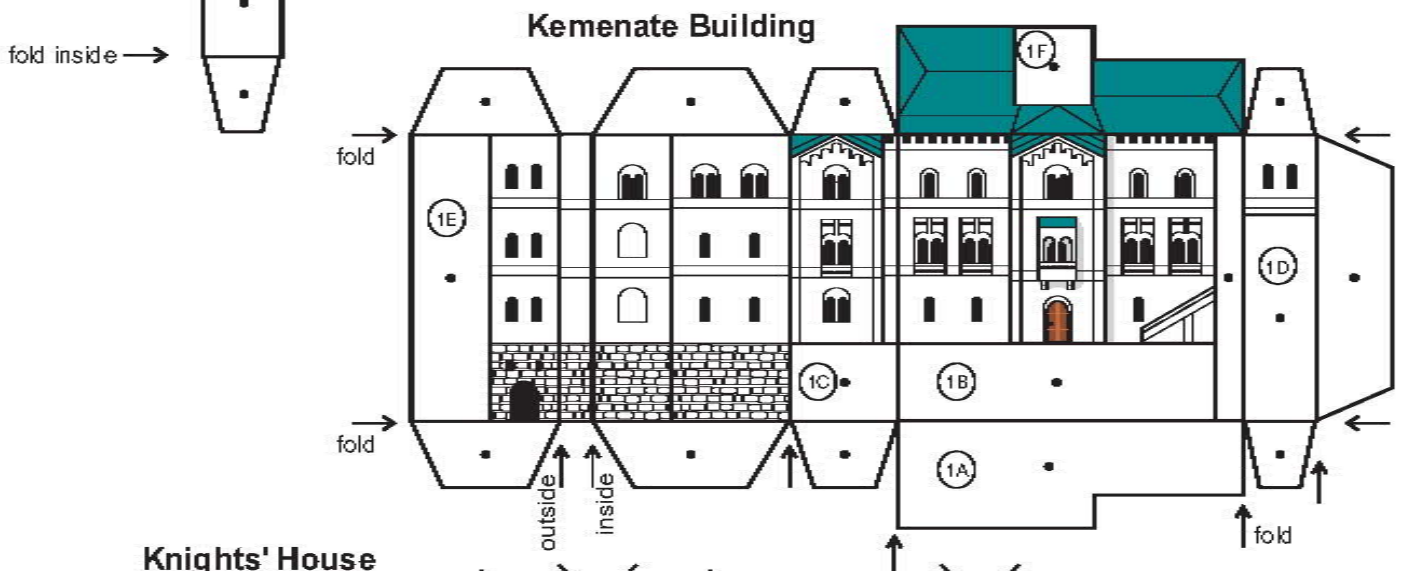
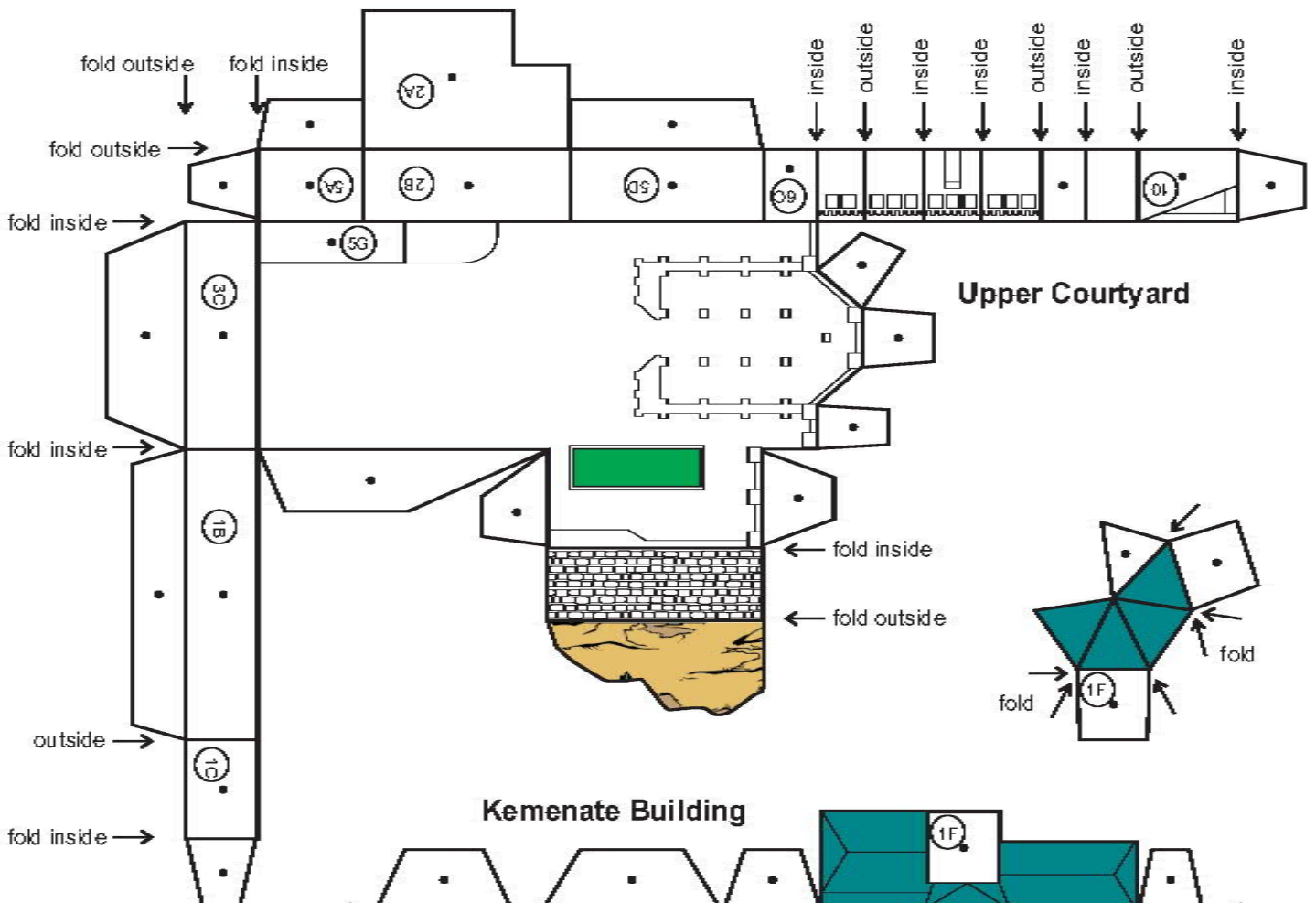

Big Building 1

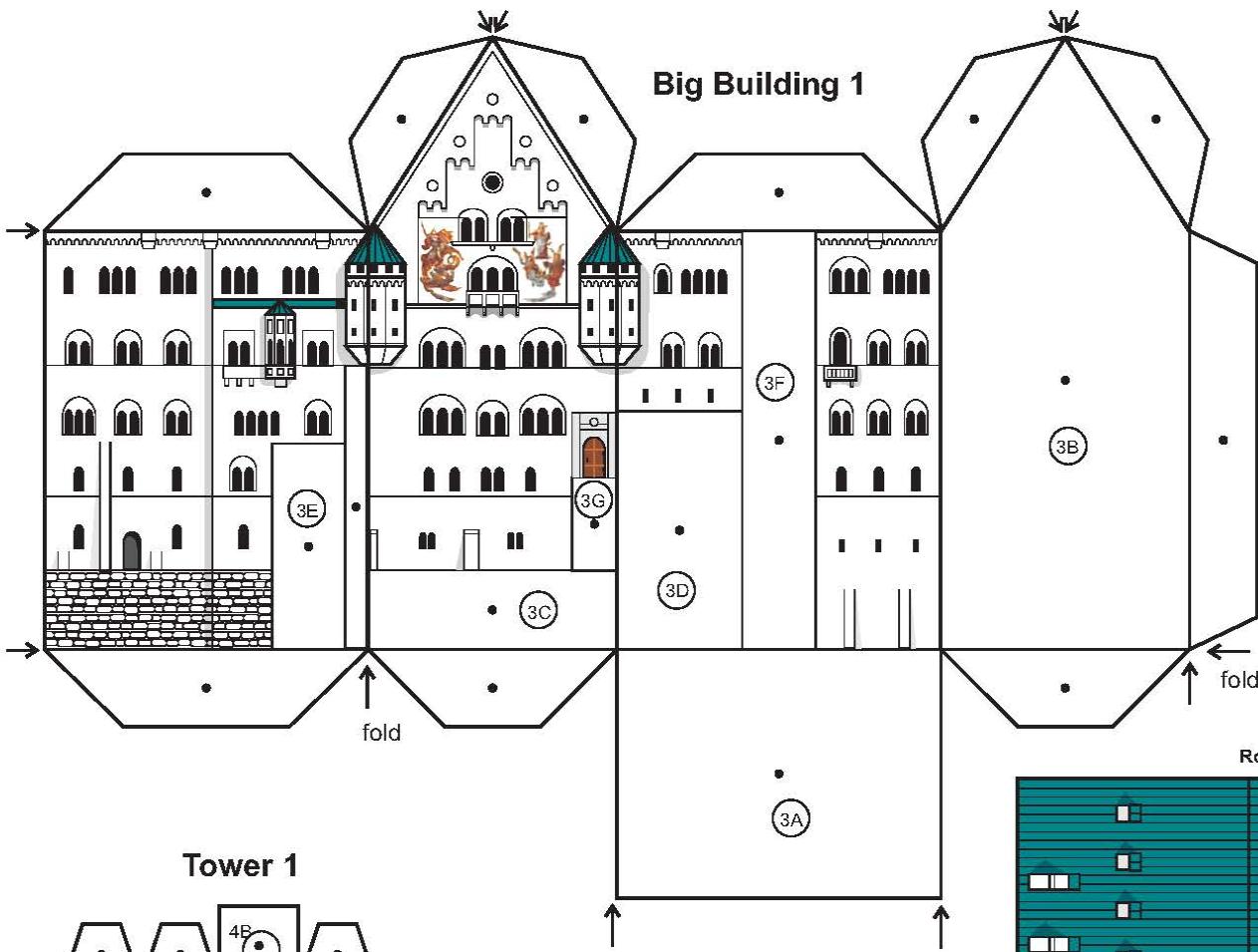

Tower 1

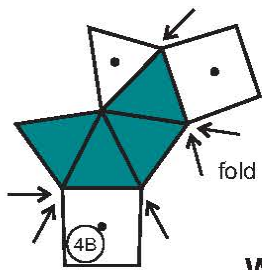
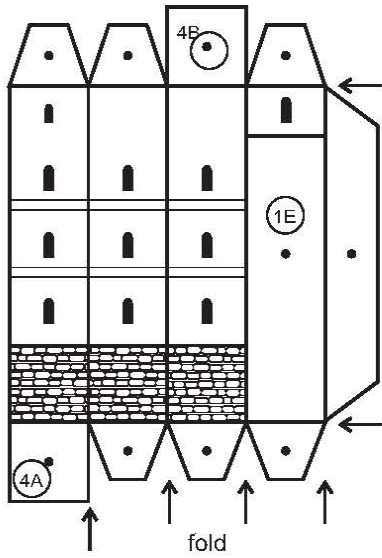

Wall 1

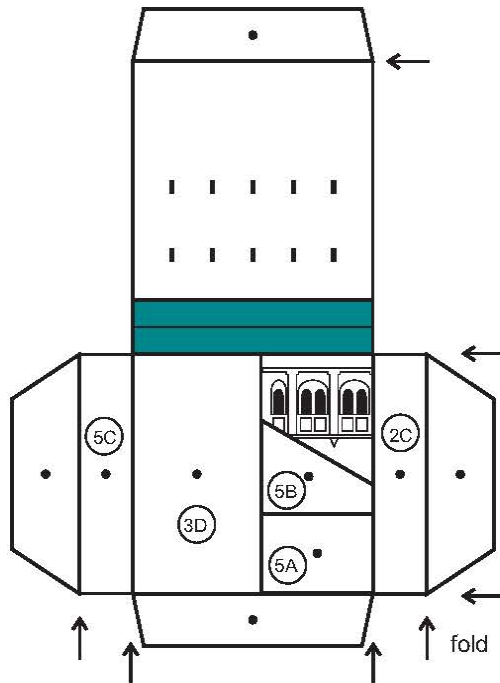

Wall 2

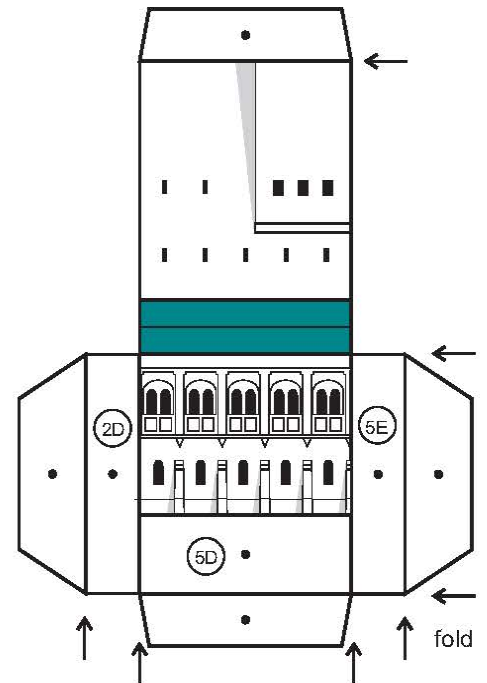

Tower 2

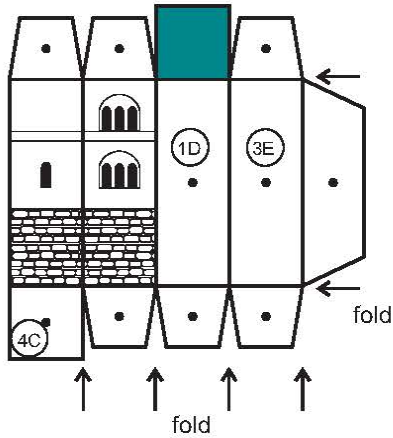

Staircase 1

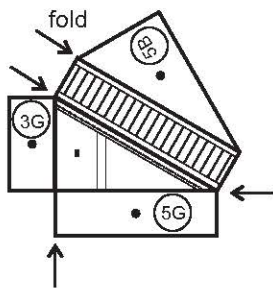

Tower 3

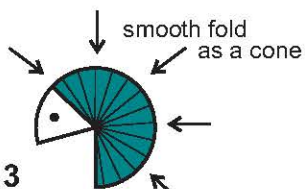
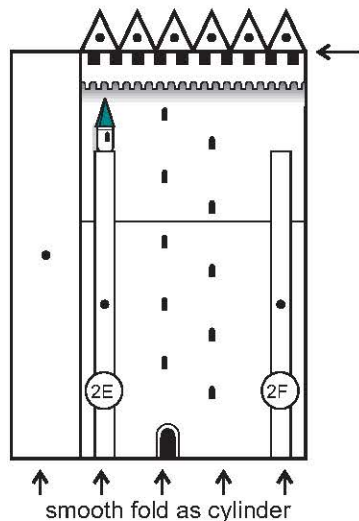

Tower 4

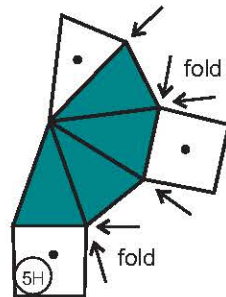
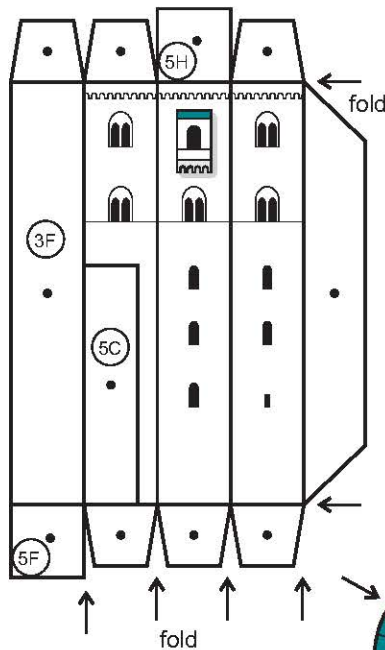

Big Square Tower

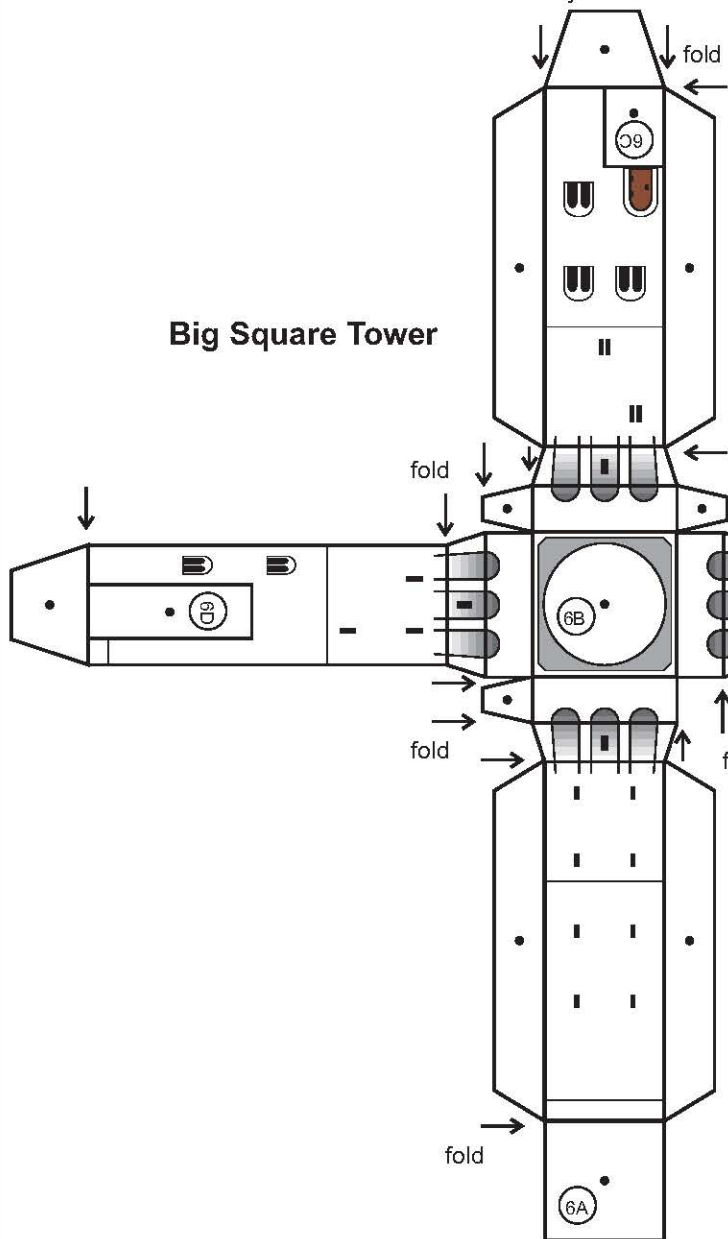

Top Part of Big Square Tower

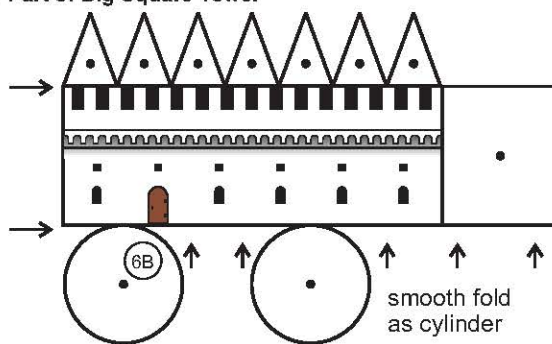

Wall 3

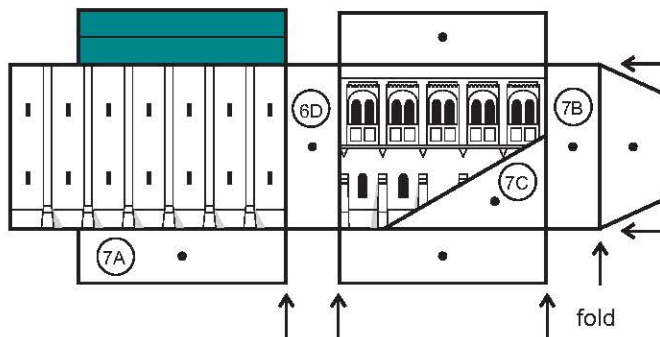

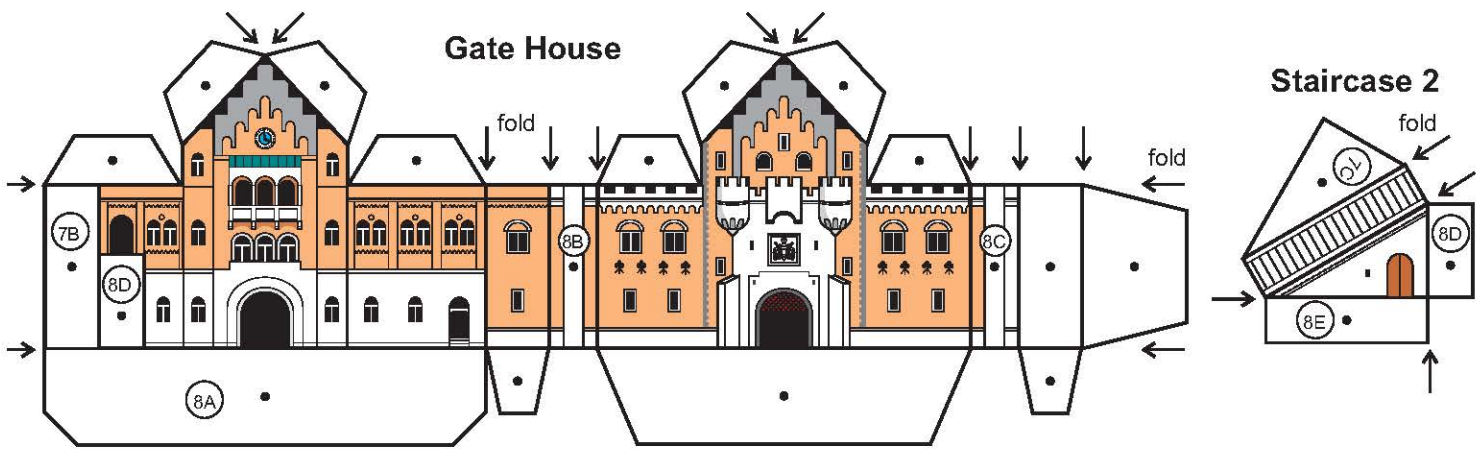

Left Tower of Gate House

Right Tower of Gate House

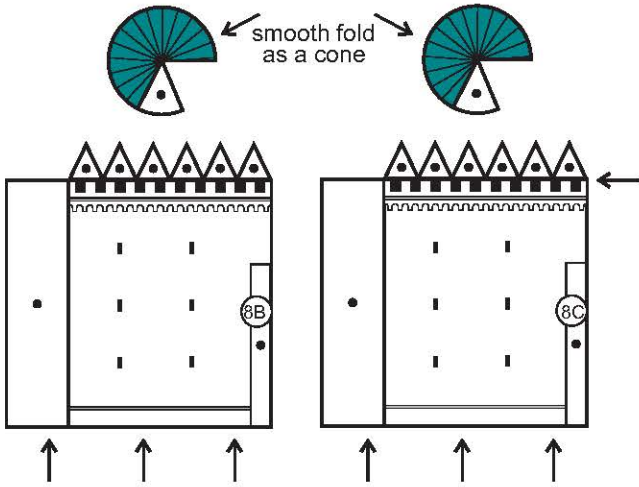

Roof of Gate House

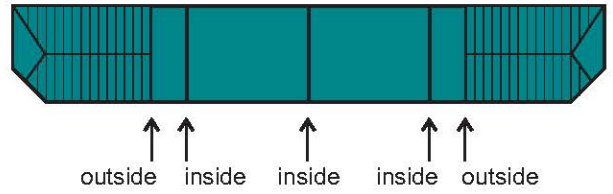

Roof of Big Building 2



Big Building 2

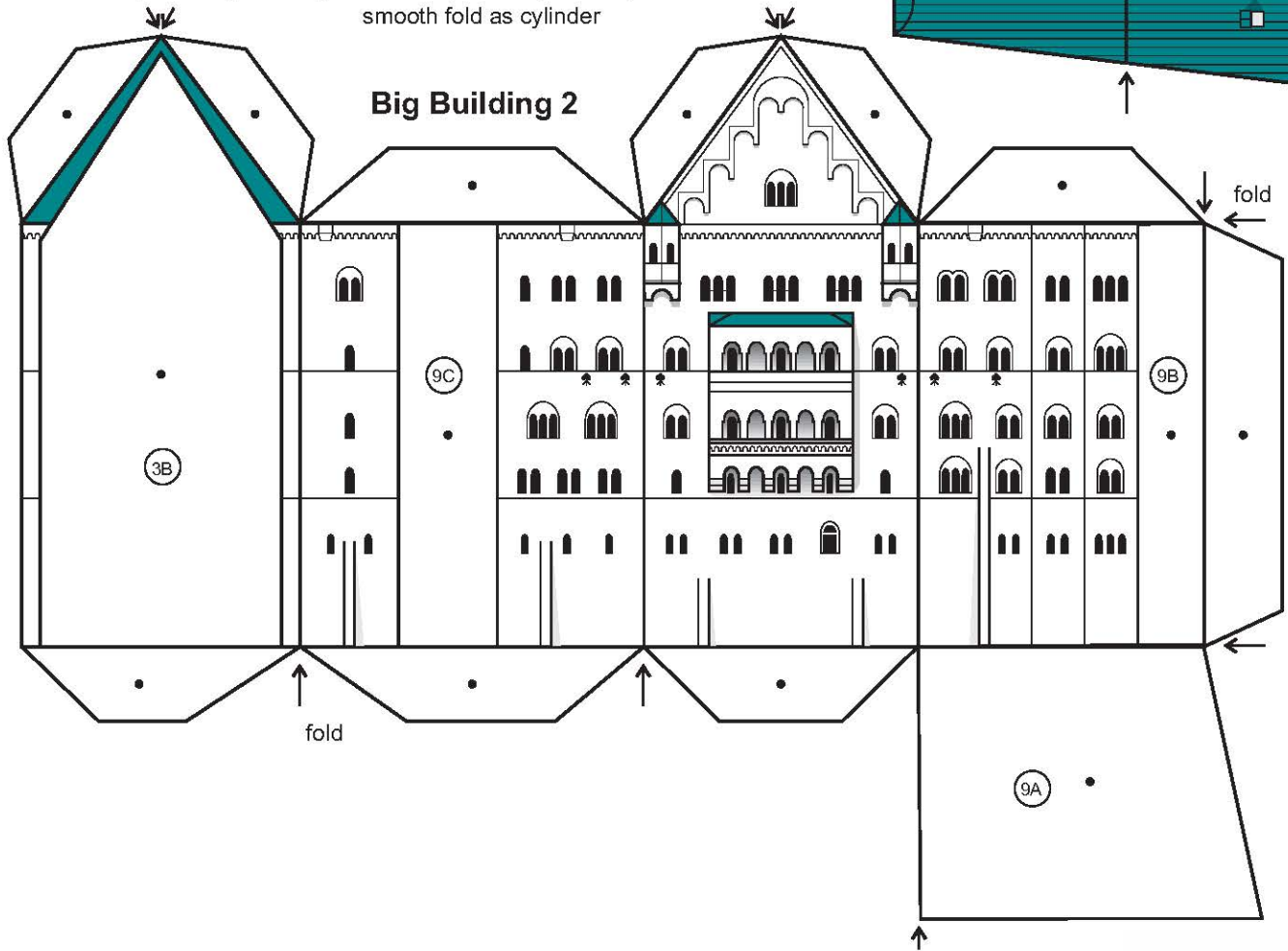

Round Tower 1

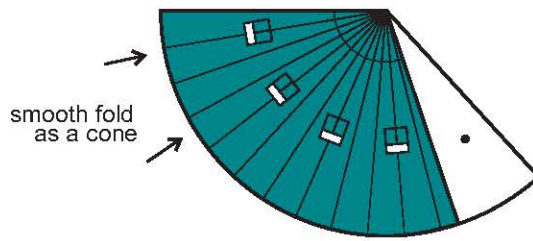

Round Tower 2

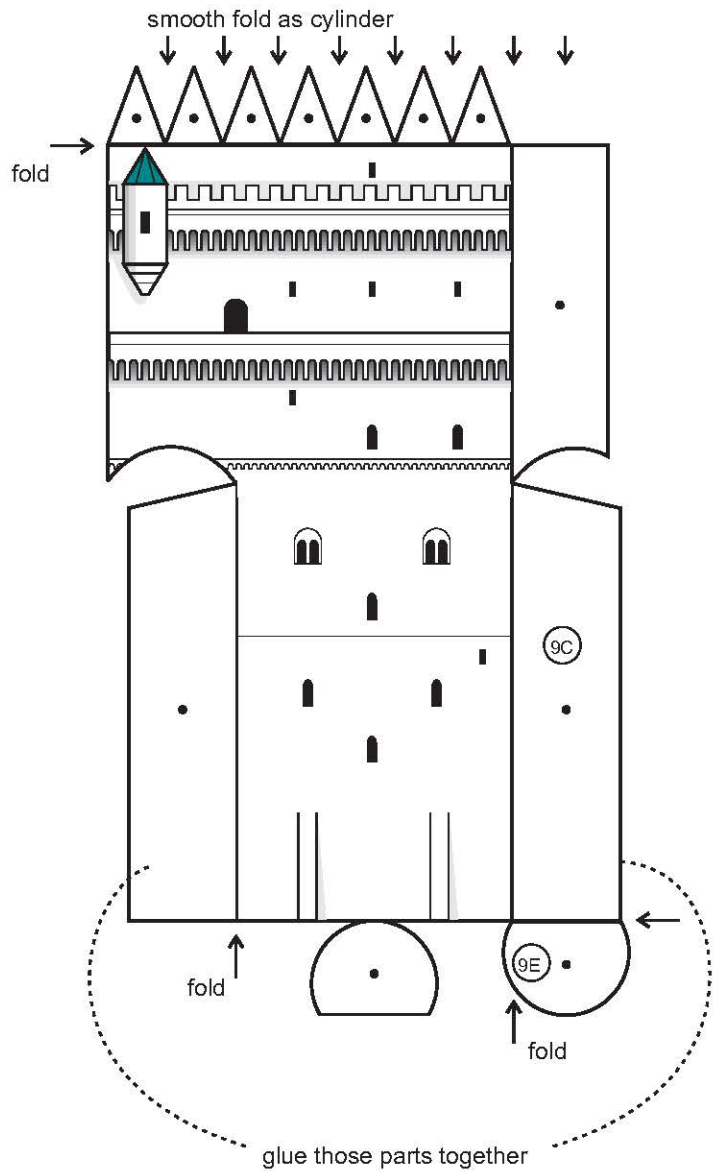
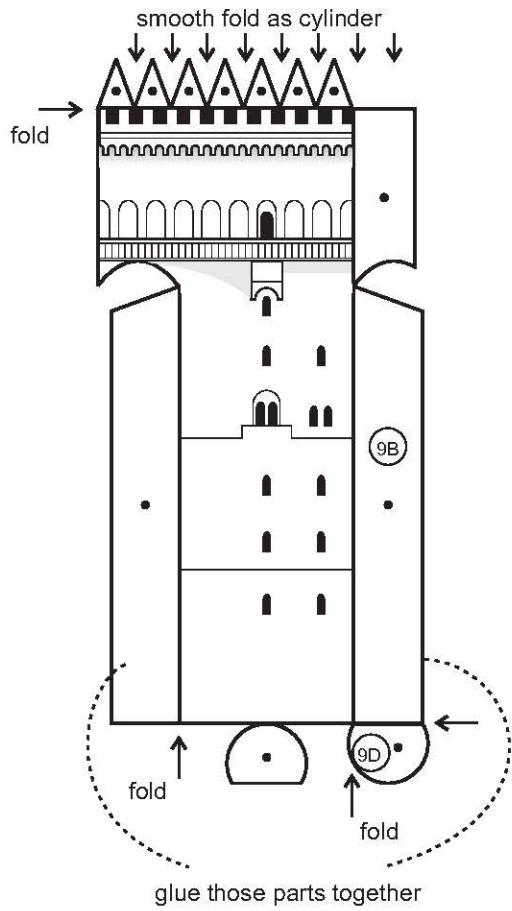
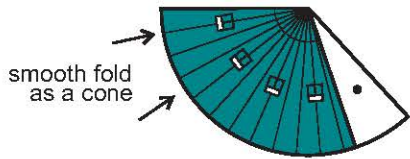

Staircase 3

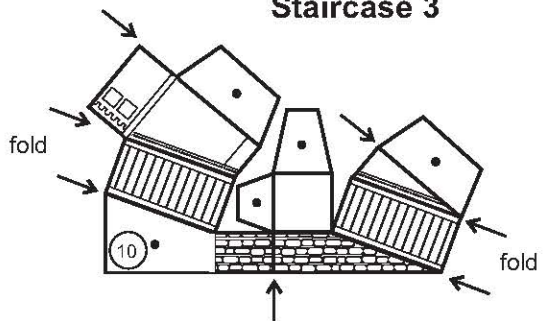

Step by step instructions

1. Print all pages, recommended paper 50 lb.
2. Cut out **Base** on page 1. This part is flat.
3. Cut out **Upper Courtyard**, fold it and glue to **Base**

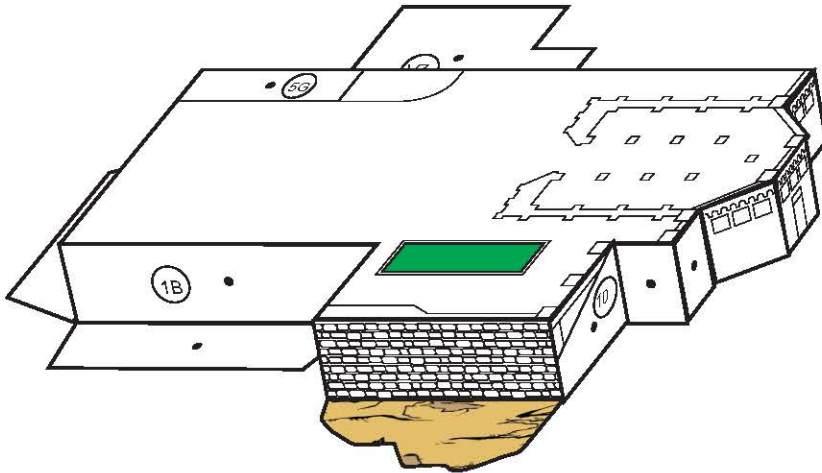

Note

what does mean here
"fold inside" and "fold outside"

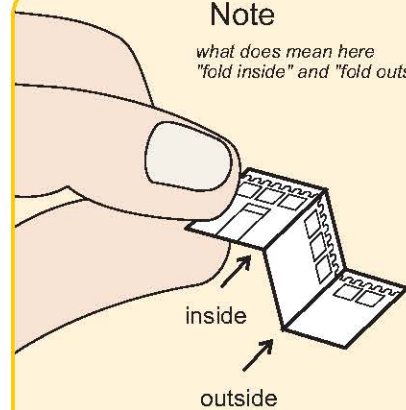

4. Fold and glue **Kemenate Building**

(better, at first glue walls, then glue building to the **Base** and **Upper Courtyard**,
and in last turn glue roof)

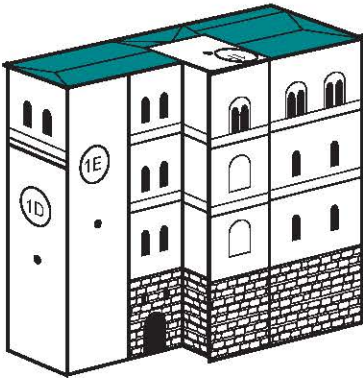

Note

if some parts are too
narrow for fingers,
use a pencil (or a ruler)
to press

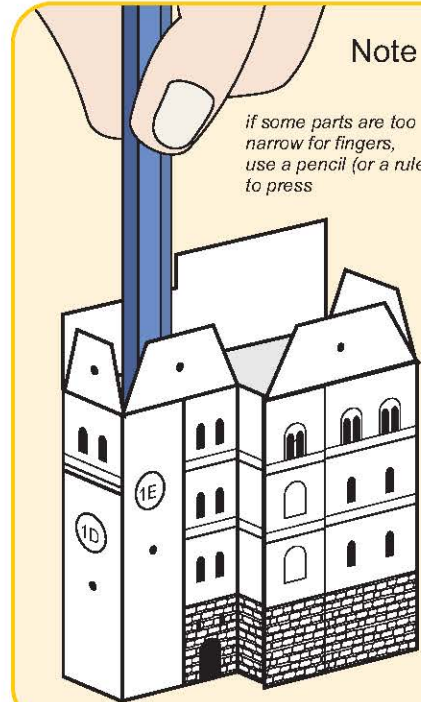

5. Fold and glue small tower on **Kemenate Building** roof

see (1F)

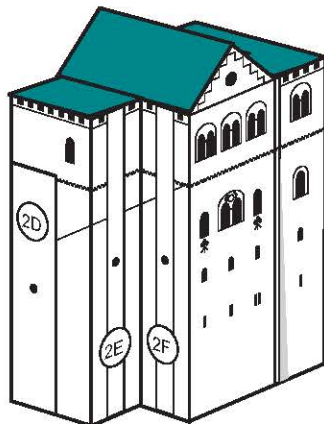

6. Fold **Knights' House** and glue to the **Base**

(also this building is glued
to **Upper Courtyard**)

7. Fold Big Building 1 and glue to the Base

(also this building is glued to Upper Courtyard and Kemenate Building)

(better, at first glue walls, then glue building to the Base using a pencil to press, and in last turn glue roof)

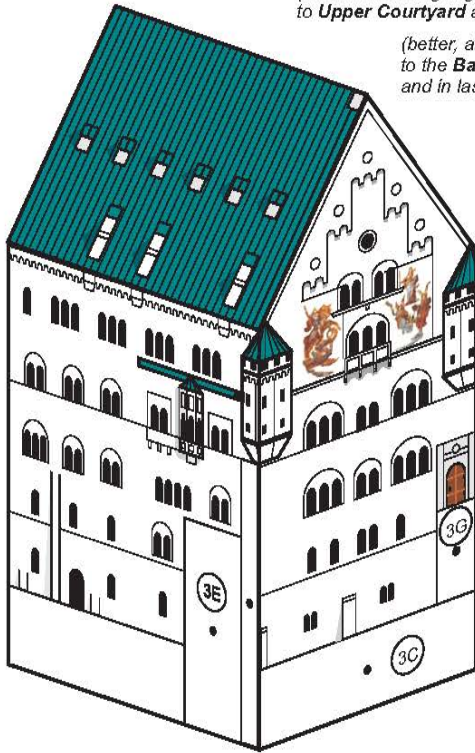

8. Fold Wall 1 and Wall 2, and glue to the Base

(also Wall 1 is glued to Upper Courtyard, Big Building 1 and Knights' House. Wall 2 is glued to Upper Courtyard and Knights' House)

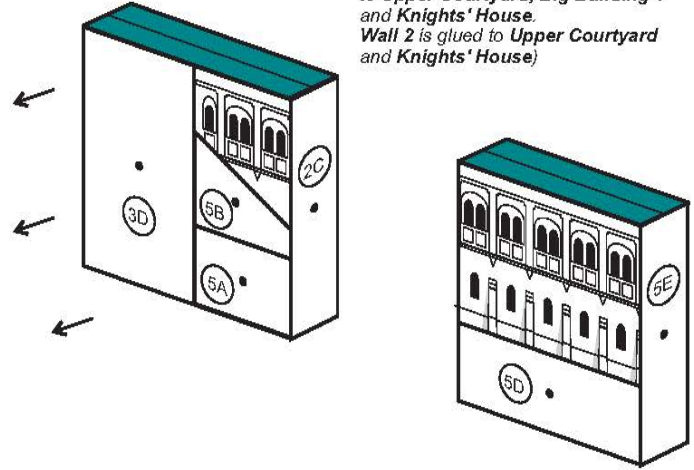

9. Fold Tower 1 and Tower 2, and glue to the Base

(also Tower 1 is glued to Kemenate Building. Tower 2 is glued to Kemenate Building and Big Building 1)

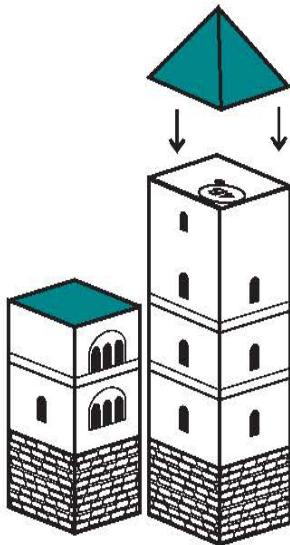

10. Fold and glue Staircase 1

(Staircase 1 is glued to Upper Courtyard, Wall 1, Knights' House and Big Building 1)

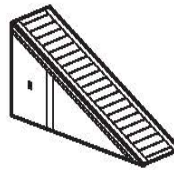

11. Fold and glue Tower 3

(Tower 3 is glued only to Knights' House)

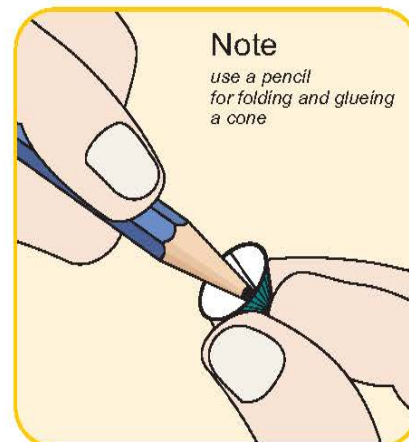
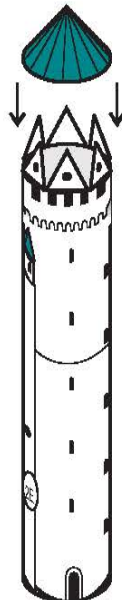

Note

use a pencil for folding and glueing a cone

12. Fold **Tower 4** and glue to the **Base**

(also **Tower 4** is glued to **Big Building 1** and **Wall 1**)



13. Fold **Big Square Tower** and glue to the **Base**

(also **Big Square Tower** is glued to **Upper Courtyard** and **Wall 2**)

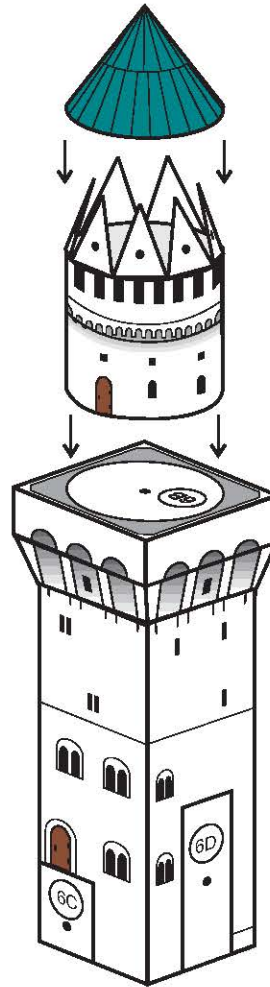

14. Fold **Wall 3** and glue to the **Base**

(also **Wall 3** is glued to **Big Square Tower**)

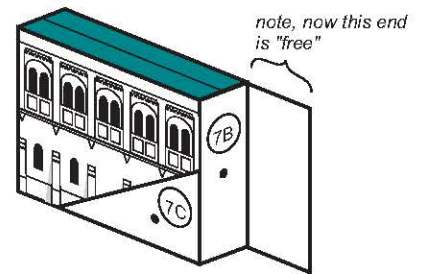

15. Fold **Gate House** and glue to the **Base**

(also **Gate House** is glued to **Wall 3**)

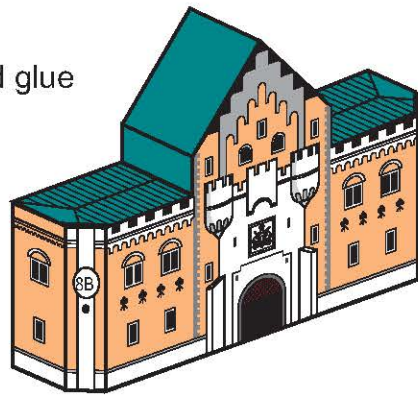

16. Fold **Left and Right Towers of Gate House** and glue those to **Gate House**



Left Tower of Gate House

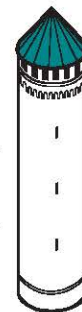

Right Tower of Gate House

17. Fold **Staircase 2** and glue to the **Base**

(also **Staircase 2** is glued to **Wall 3** and **Gate House**)

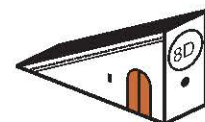

18. Fold **Big Building 2** and glue to the **Base**

(also **Big Building 2** is glued to **Big Building 1**)

(better, at first glue walls, then glue building to the **Base** using a pencil to press, and in last turn glue roof)

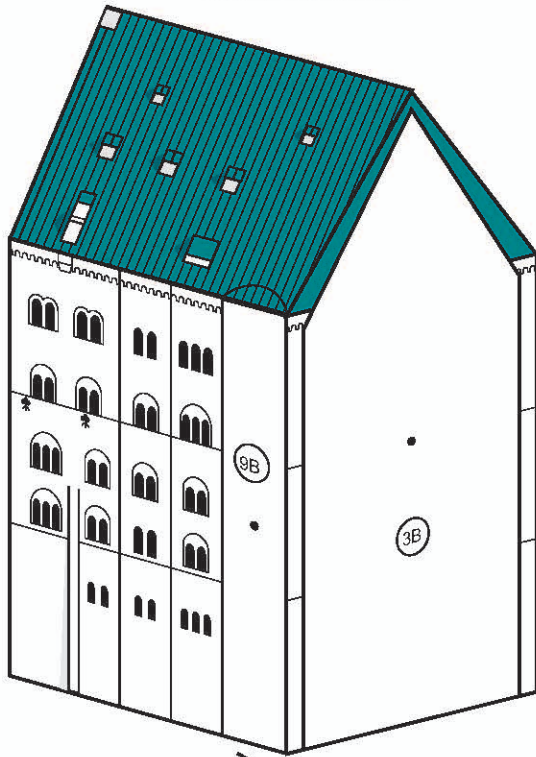

19. Fold **Round Tower 1** and glue to the **Base**

(also **Round Tower 1** is glued to **Big Building 2**)

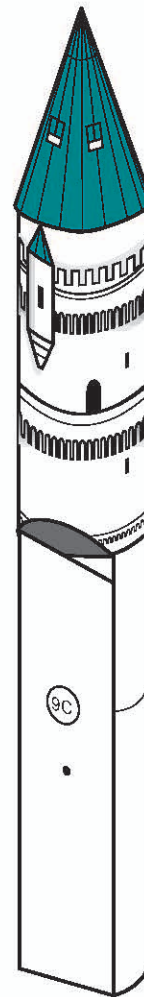

(note, this is a section of top part of the Tower)

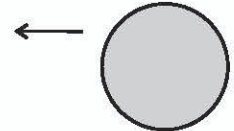

(note, this is a section of bottom part of the Tower)



20. Fold **Round Tower 2** and glue to the **Base**

(also **Round Tower 2** is glued to **Big Building 2**)

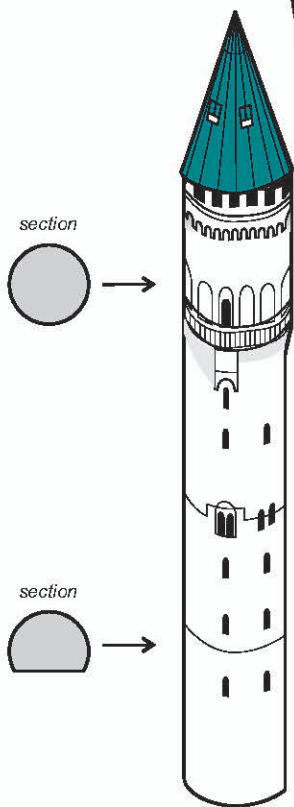

21. Fold **Staircase 3** and glue to the **Base**

(also **Staircase 3** is glued to **Upper Courtyard**)

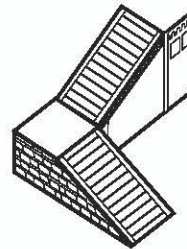

View of **Staircase 3** from another side

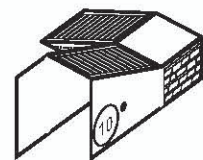

Now your Neuschwanstein Castle is ready. Have fun!